









Features:

- User-definable measurement units (F°/C°) for convenient and familiar data readings
- Port Options: Male NPTF and SAE
- Corrosion-resistant materials for challenging environments.
- User-selectable measurement and broadcast intervals. Refer to Voice of the Machine Mobile App for more information about capabilities and modalities.
- Available in unique foot and clamp designs for quick attachment to pipe or hard tubing.

Sensor Technical Data

						
Housing Material	Polycarbonate	Polycarbonate	Polycarbonate	Polycarbonate	Polycarbonate	Nylon
Port	1/4" Male NPTF	-4 SAE	1/4" Male NPTF	-4 SAE	Foot	Clamp
Wetted Parts Material	17-4 Stainless	17-4 Stainless and Nitrile	17-4 Stainless	17-4 Stainless and Nitrile	Stainless	Stainless
Measurement Range (Fluid Temperature)	-40°F to 230°F [-40°C to 110°C]	-40°F to 230°F [-40°C to 110°C]	-40°F to 230°F [-40°C to 110°C]	-40°F to 230°F [-40°C to 110°C]	-40°F to 257°F [-40°C to 125°C]	-40°F to 257°F [-40°C to 125°C]
Working Pressure	0-10k psi [0-700 bar]	0-9k psi [0-630 bar]	0-1500 psi [0-100 bar]	0-1500 psi [0-100 bar]	N/A	N/A
Max. Overload Pressure	3x	3x	2x	2x	N/A	N/A
Burst Pressure	4x	4x	3x	3x	N/A	N/A
Accuracy (at 77°F/ 25°C)	±3.0%	±3.0%	±3.0%	±3.0%	±5.0%	±5.0%
Resolution (from 14°F to 120°F) [-10°C to 44.8°C]	1°F [.56°C]	1°F [.56°C]	1°F [.56°C]	1°F [.56°C]	2°F [1.12°C]	2°F [1.12°C]
Measurement and Broadcast Intervals	User Selectable	User Selectable	User Selectable	User Selectable	User Selectable	Measurement Only (1 sec)
Response Time (minimum)	1 sec	1 sec	1 sec	1 sec	1 sec	1 sec
Ambient Temperature (battery limited)*	-4°F to 158°F [-20°C to 70°C]	-4°F to 158°F [-20°C to 70°C]	-4°F to 158°F [-20°C to 70°C]	-4°F to 158°F [-20°C to 70°C]	-4°F to 158°F [-20°C to 70°C]	-4°F to 158°F [-20°C to 70°C]
Full Range Life Cycles	> 1 million	> 1 million	> 1 million	> 1 million	> 1 million	> 1 million
Certifications	FCC, IC, CE	FCC, IC, CE	FCC, IC, CE	FCC, IC, CE	FCC, IC, CE	FCC, IC, CE
Battery (Panasonic is recommended brand)	CR123A	CR123A	CR123A	CR123A	CR123A	CR2450
IP Rating	IP65	IP65	IP65	IP65	IP65	IP65

Note: Consult QCD for other port options and port seal materials.

*Ambient temperature range can be broadened by installing Wired Power Adapter (SNWP2-B)



Temperature Sensors – Ported

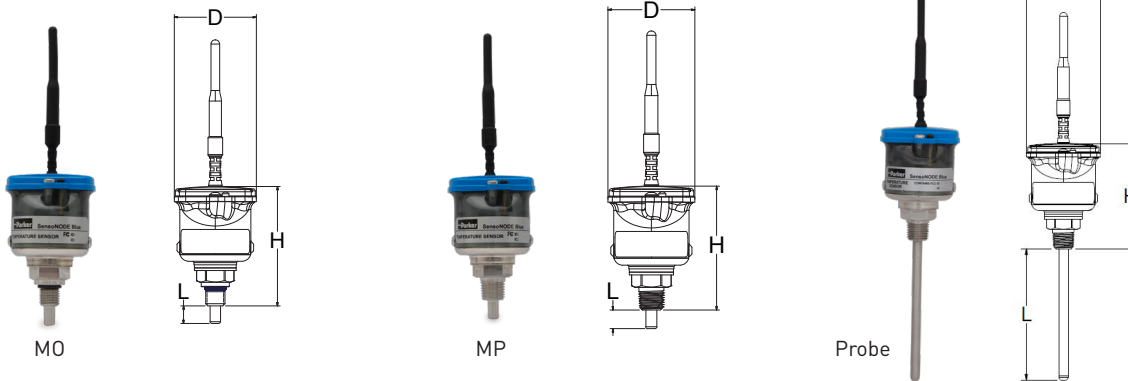

Part Number	Fluid Temperature Range	Port	D	H	L
SNT2-700-B-4M0	-40°F to 230°F [-40°C to 110°C]	-4 SAE	ø1.88" [48mm]	2.72" [69mm]	0.40" [10.16mm]
SNT2-700-B-4MP	-40°F to 230°F [-40°C to 110°C]	1/4" Male NPTF	ø1.88" [48mm]	2.66" [68mm]	0.40" [10.16mm]
SNT2-100-B-4M0-0335	-40°F to 230°F [-40°C to 110°C]	-4 SAE/Probe	ø1.88" [48mm]	2.72" [69mm]	3.35" [85mm]
SNT2-100-B-4MP-0335	-40°F to 230°F [-40°C to 110°C]	1/4" Male NPTF/Probe	ø1.88" [48mm]	2.66" [68mm]	3.35" [85mm]

Temperature Sensors – Foot and Clamp



Part Number	Fluid Temperature Range	L	H	Optimal Clamping
SNT2-0-B-FT	-40°F to 257°F [-40°C to 125°C]	2.42" [61.5mm]	2.31" [58.7mm]	> 0.25" + [> 6.4mm]
SNT-0-B-CL-KB	-40°F to 257°F [-40°C to 125°C]	5.24" [133.1mm]	3.06" [77.7mm]	0.25" to 0.15" [0.64mm-0.38.1mm]

Note: Products in catalog are currently only for sale in the U.S., Canada and Europe. For sales information outside of these regions, please contact your Parker representative.

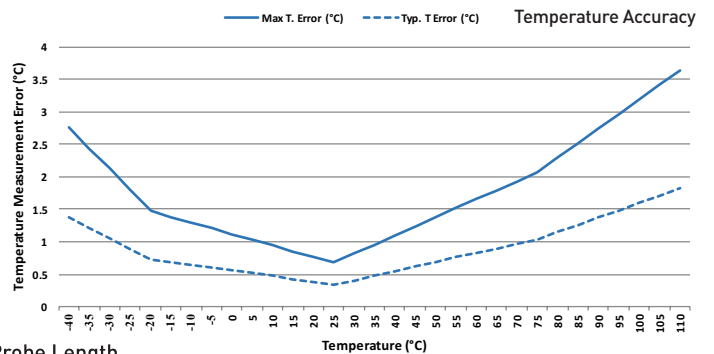

How to Order:

